

HW-E350

Crystal Surround Air Track (Active Speaker System) user manual

imagine the possibilities

Thank you for purchasing this Samsung product.
To receive more complete service,
please register your product at
www.samsung.com/register



features

HDMI

HDMI transmits digital video and audio signals simultaneously, and provides a clearer picture. The unit is also equipped with the ARC function which lets you listen to sound from your TV via an HDMI cable through the Crystal Surround Air Track. This function is only available if you connect the unit to an ARC compliant TV.

3D Depth Sound

The 3D sound feature adds depth and spaciousness to your listening experience.

Special Sound mode

You can select from 7 different sound modes - MUSIC, NEWS, DRAMA, CINEMA, SPORTS, GAME, and OFF (Original Sound) - depending on the type of content you want to enjoy.

Multi-function Remote Control

The supplied remote control can be used to control the TV connected to this unit. (Works only for Samsung TVs) The remote control has a TV hotkey that enables you to perform various operations with the simple press of a button.

Active Speaker System

This unit features an Active Speaker System that provides high sound quality in a single slim unit. This unit does not require any satellite loudspeakers or speaker cabling, which are normally associated with conventional surround sound systems.

USB Host support

You can connect and play music files from external USB storage devices such as MP3 players, USB flash memory, etc. using the Air Track's USB HOST function.

LICENSE



Dolby and the double-d symbol are registered trademarks of dolby laboratories.



Manufactured under license under U.S. Patent Nos: 5,956,674; 5,974,380; 6,487,535 & other U.S. and worldwide patents issued & pending. DTS, the Symbol, & DTS and the Symbol together are registered trademarks & DTS 2.0 Channel is a trademark of DTS, Inc. Product includes software. © DTS, Inc. All Rights Reserved.

HDMI

HDMI, the HDMI Logo, and High-Definition Multimedia Interface are trademarks or registered trademarks of HDMI Licensing LLC in the United States and other countries.

- To send inquiries and requests regarding open sources, contact Samsung via Email (oss.request@samsung.com).
- This product uses some software programs which are distributed under the Independent JPEG Group.

safety information

SAFETY WARNINGS

TO REDUCE THE RISK OF ELECTRIC SHOCK, DO NOT REMOVE THE COVER(OR BACK).

NO USER-SERVICEABLE PARTS ARE INSIDE. REFER SERVICING TO QUALIFIED SERVICE PERSONNEL.



This symbol indicates “dangerous voltage” inside the product that presents a risk of electric shock or personal injury.



This symbol indicates important instructions accompanying the product.

WARNING : To reduce the risk of fire or electric shock, do not expose this appliance to rain or moisture.

CAUTION : TO PREVENT ELECTRIC SHOCK, MATCH WIDE BLADE OF PLUG TO WIDE SLOT, FULLY INSERT.

- This apparatus shall always be connected to a AC outlet with a protective grounding connection.
- To disconnect the apparatus from the mains, the plug must be pulled out from the mains socket, therefore the mains plug shall be readily operable.

CAUTION

- Do not expose this apparatus to dripping or splashing. Do not put objects filled with liquids, such as vases on the apparatus.
- To turn this apparatus off completely, you must pull the power plug out of the wall socket. Consequently, the power plug must be easily and readily accessible at all times.

PRECAUTIONS

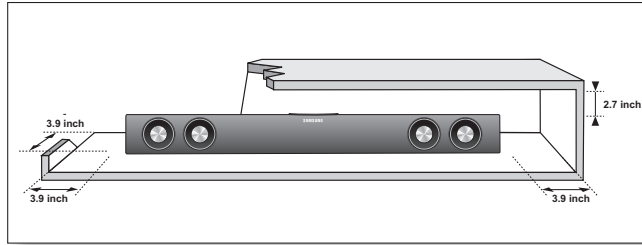

Ensure that the AC power supply in your house complies with the power requirements listed on the identification sticker located on the back of your product. Install your product horizontally, on a suitable base (furniture), with enough space around it for ventilation (3-4 inches). Make sure the ventilation slots are not covered. Do not place the unit on amplifiers or other equipment which may become hot. This unit is designed for continuous use. To fully turn off the unit, disconnect the AC plug from the wall outlet. Unplug the unit if you intend to leave it unused for a long period of time.

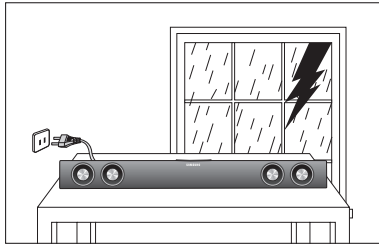

During thunderstorms, disconnect the AC plug from the wall outlet. Voltage peaks due to lightning could damage the unit.

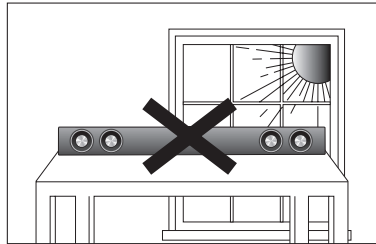

Do not expose the unit to direct sunlight or other heat sources. This could lead to overheating and malfunction of the unit.

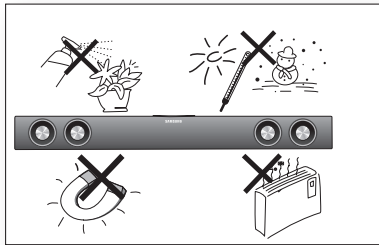

Protect the product from moisture (i.e. vases), and excess heat (e.g. fireplace) or equipment creating strong magnetic or electric fields. Disconnect the power cable from the AC supply if the unit malfunctions. Your product is not intended for industrial use. Use of this product is for personal use only.

Condensation may occur if your product has been stored in cold temperatures. If transporting the unit during the winter, wait approximately 2 hours until the unit has reached room temperature before using.

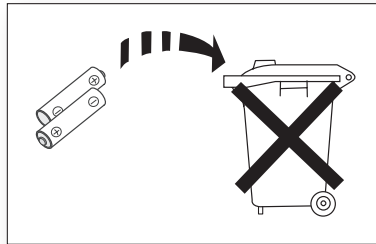

The batteries used with this product contain chemicals that are harmful to the environment. Do not dispose of batteries in the general household trash.

contents

ENG



FEATURES	2	Features
	2	License
SAFETY INFORMATION	3	Safety warnings
	4	Precautions
GETTING STARTED	6	Before reading the user's manual
	6	What's included
DESCRIPTIONS	7	Front/Rear Panel
REMOTE CONTROL	9	Tour of the remote control
CONNECTIONS	10	Installing the wall mount
	11	Installing toroidal ferrite HDMI IN/OUT cable
	11	Installing ferrite core to audio cable
	12	Connecting the Crystal Surround Air Track
FUNCTIONS	14	Basic functions
	15	Advanced functions
	19	Software upgrade
TROUBLESHOOTING	20	Troubleshooting
APPENDIX	21	Specifications

getting started

BEFORE READING THE USER'S MANUAL

Note the following terms before reading the user manual.

Icons used in this manual

Icon	Term	Definition
	Caution	Indicates a situation where a function does not operate or settings may be canceled.
	Note	Indicates tips or instructions on the page that help each function operate.

About the use of this user's manual

- 1) Be sure to be familiar with the Safety Instructions before using this product. (See page 3)
- 2) If a problem occurs, check Troubleshooting. (See page 20)







Copyright

©2012 Samsung Electronics Co.,Ltd.

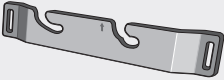
All rights reserved; no part or whole of this user's manual may be reproduced or copied without the prior written permission of Samsung Electronics Co.,Ltd.

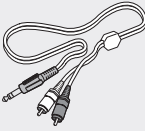
WHAT'S INCLUDED

Check for the supplied accessories shown below.

		
Remote Control / Batteries (AAA size)	Bracket-Wall Mount	User Manual
	(For HDMI cable 1EA)  (Large)  (Small) (For Audio cable 1EA)	
Audio Cable	Toroidal Ferrite Core	USB Cable



- The appearance of the accessories may differ slightly from the illustrations above.
- Use the dedicated USB cable to connect external USB devices to the unit.

FRONT/REAR PANEL

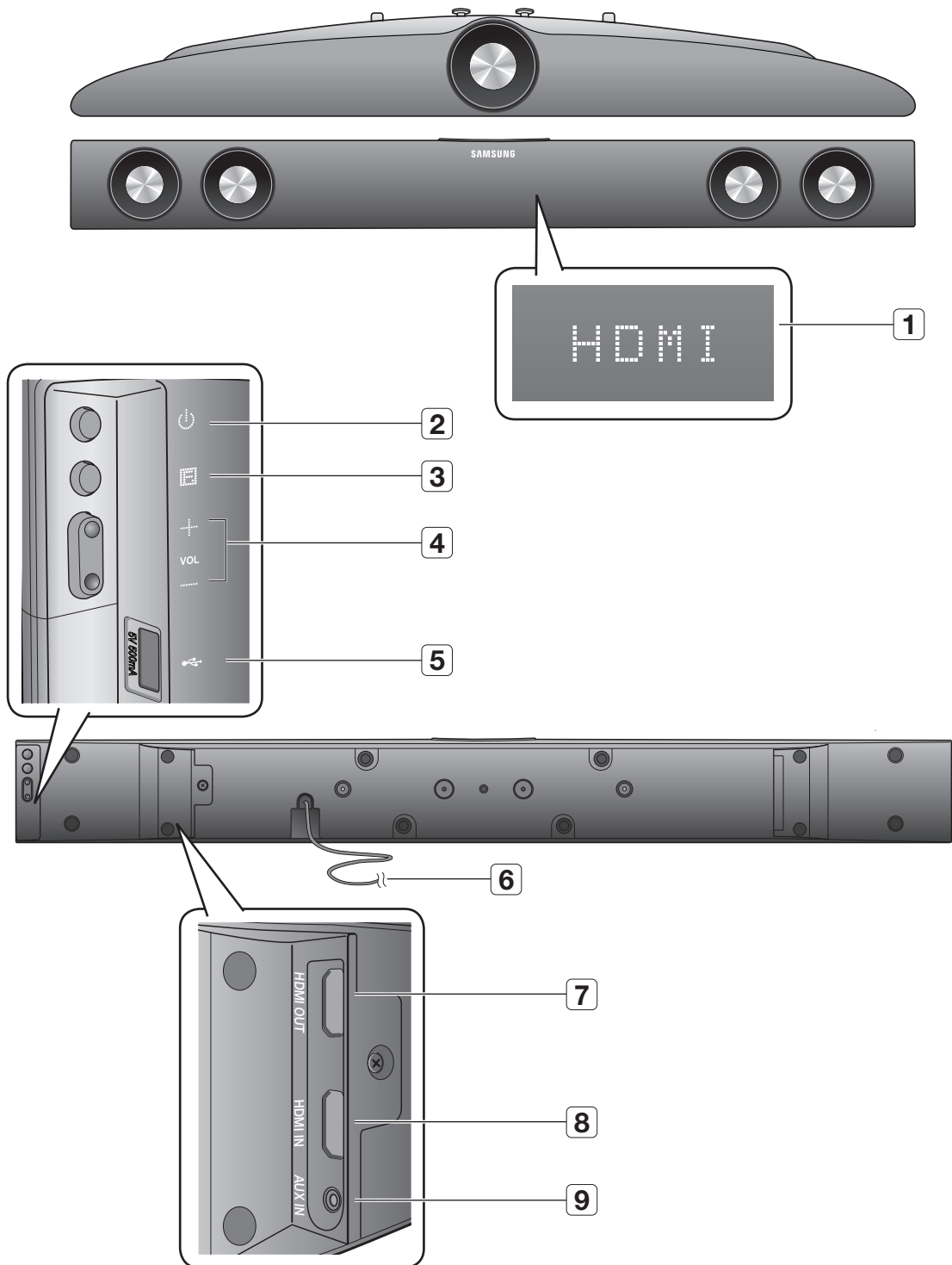

1	DISPLAY	Displays the current mode.
2	POWER BUTTON	Turns the Crystal Surround Air Track on and off.
3	FUNCTIONS BUTTON	Selects the AUX, HDMI, USB, ARC input.
4	VOLUME +/-	Controls the volume level.
5	USB PORT	Connect here and play files from external USB storage devices such as MP3 players.
6	POWER SUPPLY CABLE	Plug the power supply cable into the AC wall outlet.
7	HDMI OUT JACK	Outputs digital video and audio signals simultaneously using an HDMI cable.
8	HDMI IN JACK	Receives digital video and audio signals simultaneously using an HDMI cable.
9	AUX IN	Connect to the Analog output of an external device.



- When you turn on the power of this unit, there will be a 4 to 5 second delay before it produces sound.

remote control

TOUR OF THE REMOTE CONTROL

POWER BUTTON

Turns the Crystal Surround Air Track on and off.

SAT SOURCE

Press to select a connected SAT source. (SAT:Surround Air Track)

SOUND EFFECT

Selects the Sound Effect: (MUSIC, NEWS, DRAMA, CINEMA, SPORTS, GAME, OFF (Original Sound))

SAT MUTE

Mutes the sound from the unit. Press again to restore the sound to the previous volume level.

VOLUME

Adjusts the volume level of the unit.

REPEAT

Select Repeat File, All, Random.

DRC, DIMMER

You can use this function to enjoy Dolby Digital sound when watching movies at low volume at night (Standard, MAX, MIN). You can control the brightness of the Display.

CONTROL BUTTON

Play, pause or stop playing a Music file, or search for the Music file next or back.

TV SOURCE

Press to select a connected TV's video source.

TV PRE-CH

Moves to the previous TV channel

TV MUTE

Mutes the sound from the TV. Press again to restore the sound to the previous volume level.

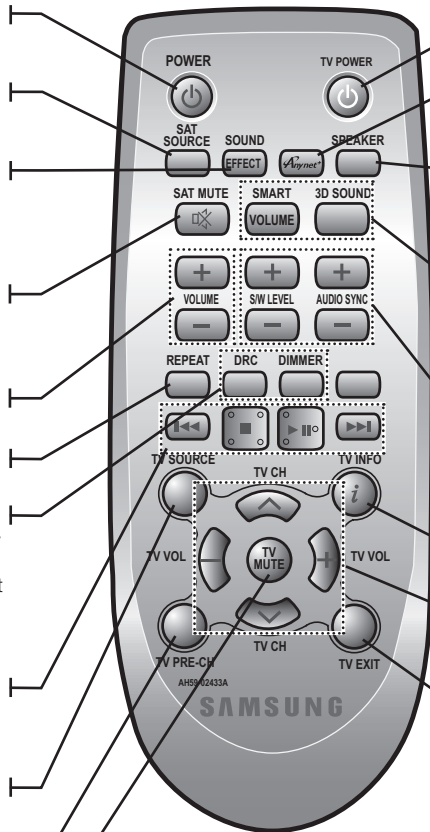

TV POWER BUTTON

Turns your Samsung TV on and off.

Anynet+

Anynet+ is a function that enables you to control other Samsung Devices with your Samsung TV's remote control.

SPEAKER

This button allows you to choose to listen to audio from the Air track or your TV. (This function supports the via an HDMI cable.)

SMART VOLUME, 3D SOUND

Regulates and stabilizes the volume level against a drastic volume change. This feature adds depth and spaciousness to the sound.

SW LEVEL, AUDIO SYNC

Adjusts the Subwoofer level. Used to help sync video to audio when connected to a digital TV.

TV INFO

Display current TV status.

TV CHANNEL, TV VOLUME

Switches between the available TV channels. Adjusts the TV volume level.

TV EXIT

Exits TV (functions same as the EXIT button of the TV remote control)



- SAT stands for Surround Air Track, which is a Samsung's proprietary name.
- The remote control can operate TVs made by SAMSUNG only.
- Depending on the TV you are using, you may not be able to operate your TV with this remote control. If you can't, operate the TV using the TV's remote control.

Installing batteries in the Remote Control

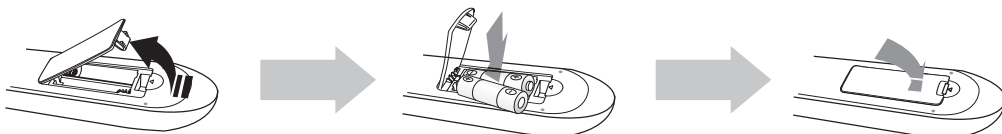

1. Lift the cover at the back of the remote control upward as shown.
2. Install two AAA size batteries. Make sure to match the "+" and "-" ends of the batteries with the diagram inside the compartment.
3. Replace the cover. Assuming typical TV usage, the batteries last for about one year.

Operation Range of the Remote Control

You can use the remote control up to 23 feet (7 meters) in a straight line from the unit. You can also operate the remote at a horizontal angle of up to 30° from the remote control sensor.

connections

INSTALLING THE WALL MOUNT

You can use the wall mount bracket to mount this unit on a wall.

Installation Precautions

- Install on a vertical wall only.
- For the installation, avoid a location with high temperature or humidity, or wall that cannot sustain the weight of the set.
- Check the strength of the wall. If the strength of the wall is insufficient for the product installation, make sure to reinforce the wall before the installation.
- Check the material of the wall. If the wall is made of plaster board, marble, or iron board, purchase and use the appropriate fixing screws or mollys.
- Connect cables from the unit to external devices before you install it on the wall.
- Make sure the unit is turned off and unplugged before you install it. Otherwise, it may cause an electric shock.

1. Place the wall mount bracket on a wall surface and then secure it with two screws (not supplied).
If you are hanging the unit below a TV, be sure to install the wall mount bracket so that the arrow (↑) is placed in the center of the TV.
Also make sure the unit is at least two inches (5 cm) below the TV.

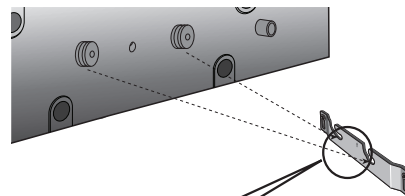
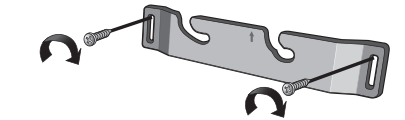

2. Fit the unit into the corresponding slots of the wall mount bracket. For secure installation, make sure the mounting studs slide firmly down into the bottom of the slots.

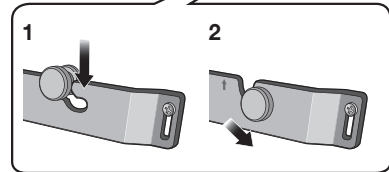

3. The installation is complete.



↑ 2 inches (5 cm) or more



- Do not hang onto the installed unit and avoid any impact to the unit.
- Secure the unit firmly to the wall so that it does not fall off. If the unit falls off, it may cause an injury or damage to the product.
- When the unit is installed on a wall, please make sure that children do not pull any of the connecting cables, as it may cause it to fall.
- For the optimal performance of a wall mount installation, keep the speaker system at least 2 inches (5 cm) away from the TV.

INSTALLING THE TOROIDAL FERRITE ON THE HDMI IN/OUT CABLE

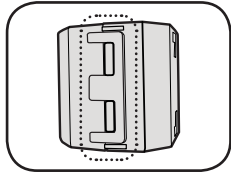

Lift up to release the lock and open the core.

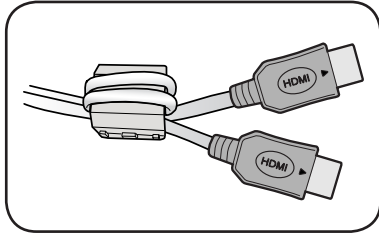
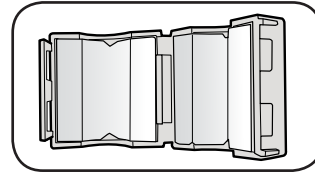

Close the lock back.

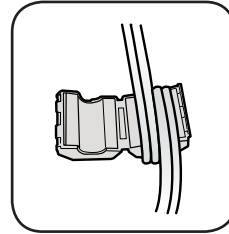

Wind both HDMI IN/OUT cables together, make one turn around the core.
(Start winding at 5-10cm away from the plugs)

INSTALLING THE FERRITE CORE ON THE AUDIO CABLE

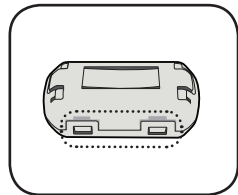

Lift up to release the lock and open the core.

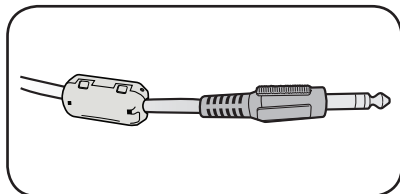
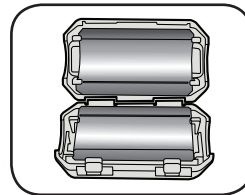

Close the lock back.

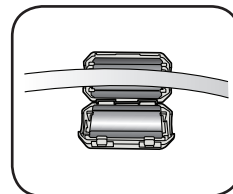

Place the audio cable on the opened core.

CONNECTING THE CRYSTAL SURROUND AIR TRACK

HDMI is a standard digital interface for connecting to such devices as a TV, projector, DVD player, Blu-ray player, set top box and more.

HDMI removes any loss of signal from analog conversion, enabling you to enjoy video and audio sound quality as it was originally created in the digital source.

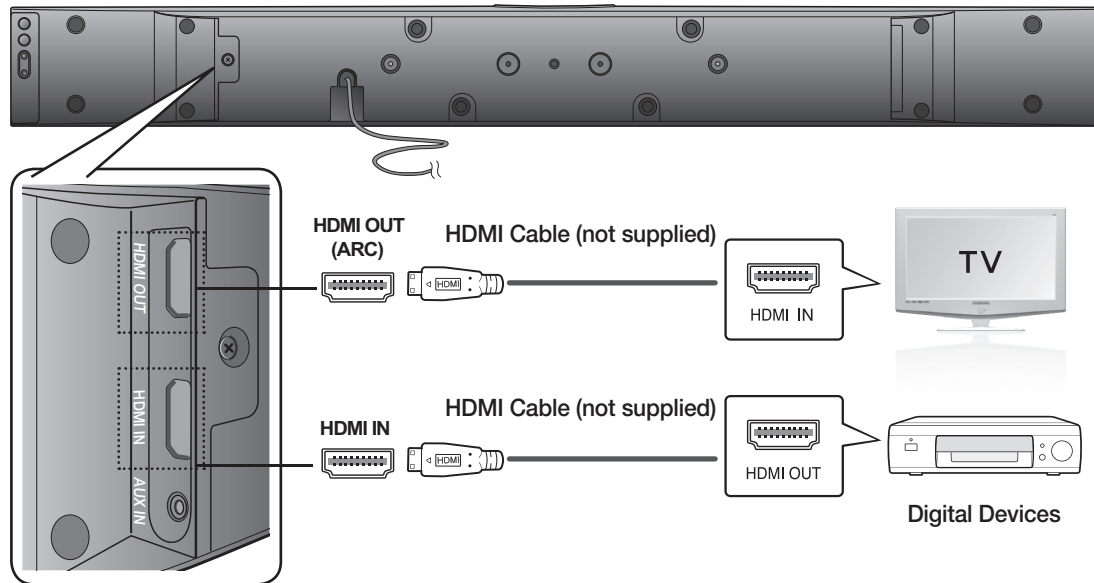

HDMI IN

Connect an HDMI cable (not supplied) from the HDMI IN jack on the back of the product to the HDMI OUT jack on your digital devices.

and,

HDMI OUT (HDMI)

- Connect an HDMI cable from the HDMI OUT jack on the back of the product to the HDMI IN jack on your TV.



- HDMI is an interface that enables the digital transmission of video and audio data with just a single connector.

HDMI OUT (ARC)

- The ARC function allows digital audio to output via the HDMI OUT (ARC) port.
It can be enabled only when the Air Track is connected to a TV that supports the ARC function.
- Anynet+ must be turned on.



- This function is not available if the HDMI cable does not support CEC.

CONNECTING THE CRYSTAL SURROUND AIR TRACK

This section explains ways (analog) of connecting the unit to a TV.

This unit is equipped with one audio analog jack for connecting a TV.

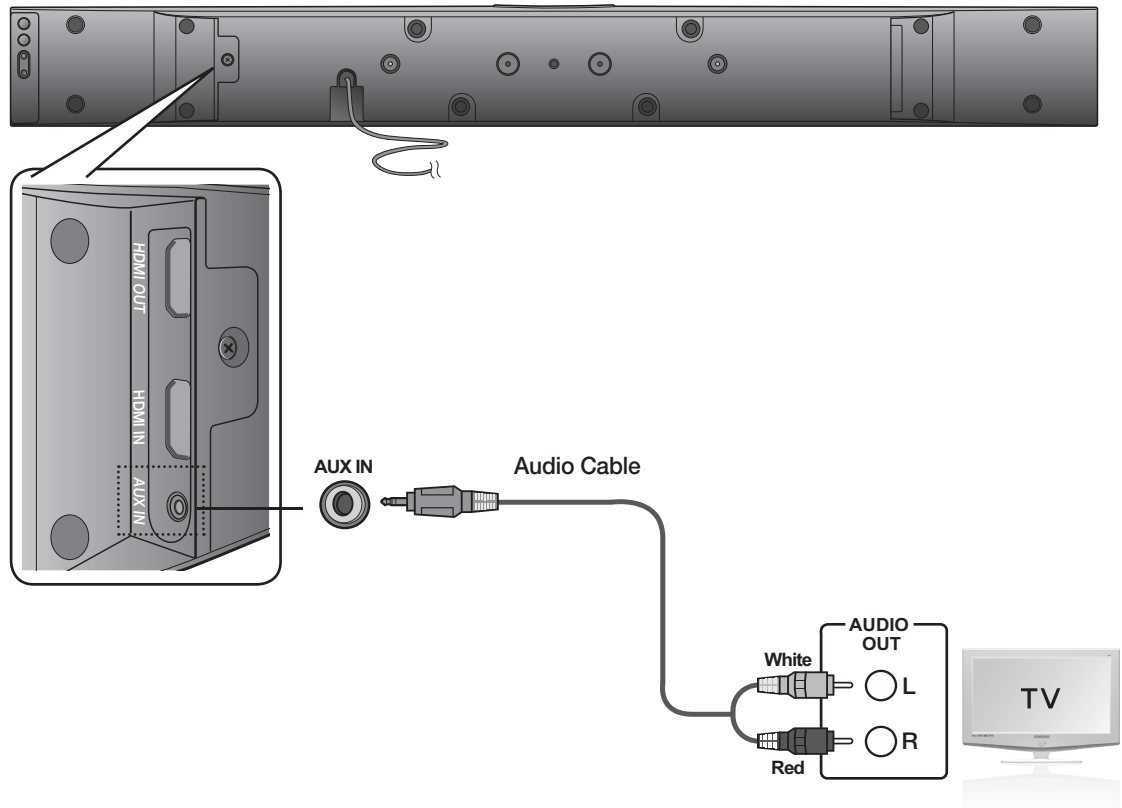

AUX IN

Connect AUX IN on the main unit to the AUDIO OUT of the TV or Source Device. Be sure to match connector colors.



- Do not connect the power cord of this product or your TV to the wall outlet until all connections between components are complete.
- Before moving or installing this product, be sure to turn off the power and disconnect the power cord.
- If you select 'AUX' without connecting the Audio Cable, the set is turned off automatically after 20 minutes.

functions

BASIC FUNCTIONS

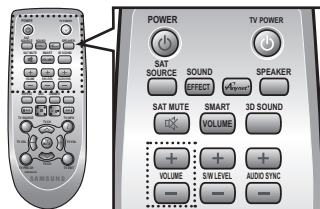
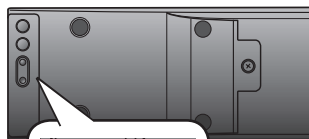
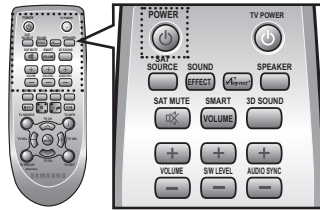
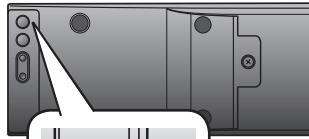

Turning the power on/off

1. Press the **POWER** (⏻) button in the right corner of the front panel.
or,
Press **POWER** on the remote control to turn on the power.
2. Press the **POWER** (⏻) button in the right corner of the front panel.
or,
Press **POWER** on the remote control again to turn off the power.

Adjusting the volume

Press the **VOLUME +/-** button in the right corner of the front panel.

or,

Press **VOLUME +/-** on the remote control to increase or decrease the volume level.

- The numeric value of the volume level appears in the front panel display.



- The volume level increases or decreases when you press VOLUME +/-.
- If you want to enjoy the sound only from the Crystal Surround Air Track, you must turn off the TV's speakers in the Audio Setup menu of your TV. Refer to the owner's manual supplied with your TV.

ADVANCED FUNCTIONS

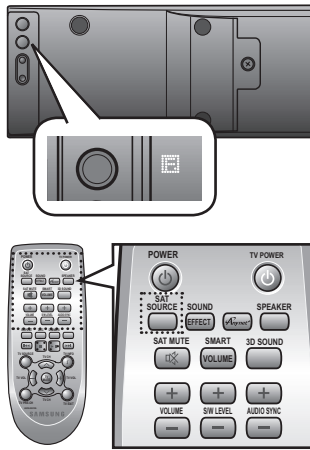

Using the input mode

You can select either AUX, HDMI, USB input or ARC input. Press an appropriate button on the remote control to select a desired mode, or press  to select one from: AUX, HDMI, USB or ARC mode.

Input mode	Display
AUX input	AUX
HDMI input	HDMI
USB mode	USB
ARC mode	ARC

The unit turns off automatically in the following situations:

- Aux Mode: If no cable is inserted in the jack for 20 minutes.
- USB Mode: If the “NO USB” or “Stop” state lasts for 20 minutes.

To connect the Crystal Surround Air Track to a USB HOST device

1. Connect the USB device to the USB port on the side of the unit.
2. Press the  button on the front panel of the Air Track repeatedly until **USB** appears.
 - Each time the button is pressed, the selection changes as follows :
AUX ⇒ HDMI ⇒ USB ⇒ ARC
3. **USB** appears on the display screen and then disappears.
 - The Crystal Surround Air Track connection is complete.
 - It automatically turns off (Auto Power Off) if no USB device has been connected for more than 20 minutes.

Before you connect a USB device

Compatibility: USB storage

- If the file name of a folder on a USB device exceeds 10 characters, it is not displayed on the VFD.
- This product may not be compatible with certain types of USB storage media.
- The file systems FAT16 and FAT32 are supported.
 - The NTFS file system is not supported.
- Connect a USB device directly to the USB port of the product. Otherwise, you may encounter a USB compatibility problem.
- Do not connect multiple storage devices to the product via a multi-card reader. It may not operate properly.
- Digital camera PTP protocols are not supported.
- Do not remove the USB device while it is being read.
- DRM-protected music files (MP3, WMA) from a commercial web site will not be played.
- External HDDs are not supported.
- Compatibility list

Format	Music	
File name	MP3	WMA
File extension	.MP3	.WMA
Bit rate	80~320 kbps	56~128 kbps
Version	-	V8
Pixel	-	-
Sampling Frequency	44.1KHz	44.1KHz

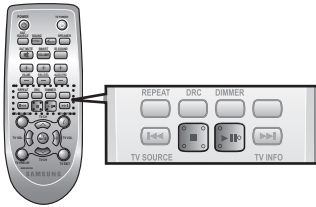

Play/Pause/Stop

During playback, press the ►||,■ button.

- Press the ►|| button again to stop playing the file temporarily. Press the ►|| button to play the selected file.
- To stop playback, press the Stop (■) button during playback.

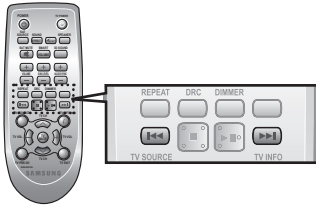

Skip Forward/Back

During playback, press the ◀◀,▶▶ button.

- When there is more than one file and you press the ▶▶ button, the next file is selected.
- When there is more than one file and you press the ◀◀ button, the previous file is selected.

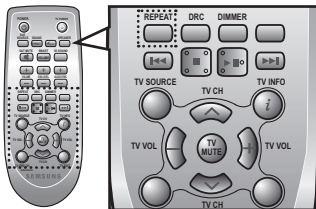

Using the REPEAT function

Repeat playback allows you to repeatedly play a file, repeat all, randomly play files, or turn Repeat off.

Press the **REPEAT** button.

- **REPEAT FILE** : Repeat playing a track
- **REPEAT ALL** : Repeat playing all tracks
- **REPEAT RANDOM** : Plays tracks in random order. (A track that has already been played may be played again.)
- **REPEAT OFF** : Cancels Repeat Playback.



- You can set the REPEAT function during the playback of music from a USB drive.

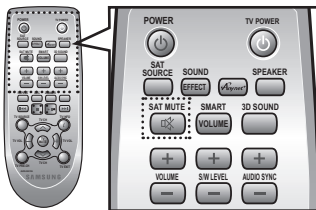

Muting the sound

This is useful when answering a doorbell or telephone call.

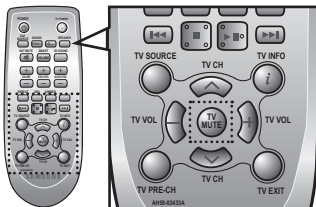

1. To mute sound of this unit, press the **SAT MUTE** (🔇) button of the remote control.
2. To mute the TV, press the **TV MUTE** button of the remote control.
3. Press **SAT MUTE** (🔇)/ **TV MUTE** on the remote control again (or press **VOLUME +/-**) to restore the sound.

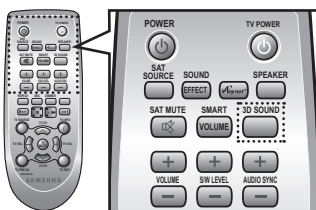

Using the 3D Depth Sound function

The 3D Sound feature adds depth and spaciousness to the sound.

Press **3D SOUND** on the remote control.

- Each time the button is pressed, the selection changes as follows :
3D SOUND LOW ➔ 3D SOUND HIGH ➔ 3D SOUND OFF



- When you turn on the 3D Depth Sound, the Sound Effect will automatically change to OFF.

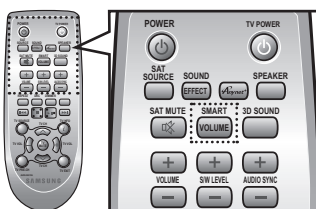

Using the SMART VOLUME function

This will regulate and stabilize the volume level against a drastic volume change caused by a channel change or scene transition.

Press **SMART VOLUME** on the remote control.

- Each time the button is pressed, the selection changes as follows :
SMART VOLUME ON ➔ SMART VOLUME OFF

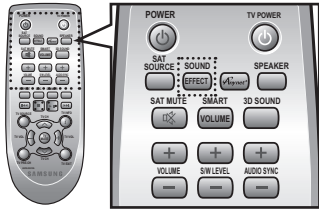

Using the Sound effect

You can select from 7 different sound modes - MUSIC, NEWS, DRAMA, CINEMA, SPORTS, GAME, and OFF (Original Sound) - depending on the type of sources you want to enjoy.

Press **SOUND EFFECT** on the remote control.

- Select **OFF** mode if you want to enjoy the original sound.



- We recommend that you select a Sound Effect based on the source material and your personal taste.
- When you choose the Sound Effect (except OFF), the 3D Depth Sound will automatically be turned OFF.

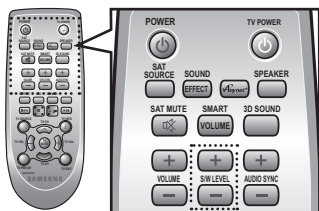

Using the S/W LEVEL function

You can control the base volume with the S/W LEVEL button on the Remote control.

1. Press the **S/W LEVEL** button on the Remote control.
2. **"SW 0"** appears on the Display.
3. Press **"+"** or **"-"** button on the **LEVEL** key if you want to increase or decrease the subwoofer volume. You can set it from SW -6 to SW +6.

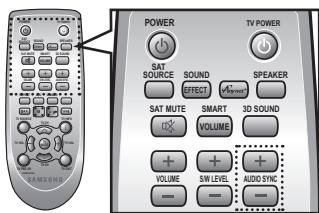

Using the AUDIO SYNC function

Video may look slower than the audio if Air Track is connected to a digital TV. If this occurs, adjust the audio delay time to match the video.

Press **AUDIO SYNC +/-** button on the remote control.

- You can use +, - button to set the audio delay time between 0 ms and 300 ms.



- In the USB mode, the Audio Sync function may not work.

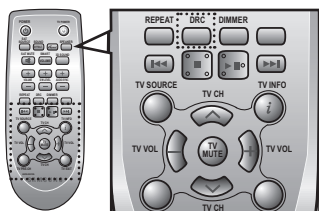

Using the DRC function

This feature balances the range between the loudest and quietest sounds. You can use this function to enjoy Dolby Digital sound when watching movies at low volume at night.

Press **DRC** on the remote control of this unit.

- Each time the button is pressed, the selection changes as follows :
DRC MIN ➔ DRC STANDARD ➔ DRC MAX

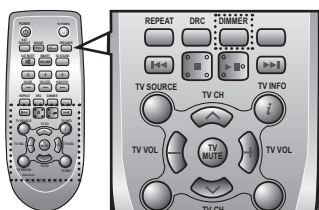

Using the DIMMER function

This feature control the brightness of the Display.

Press **DIMMER** on the remote control of this unit.

- Each time the button is pressed, the selection changes as follows :
DIMMER ON ➔ DIMMER OFF

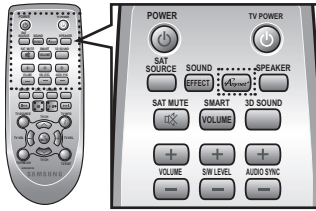

Using the Anynet+(HDMI-CEC) function

Anynet+ is a function that enables you to control other Samsung Devices with your Samsung TV's remote control.

The Anynet+ function turns on and off each time you press **Anynet+**.

1. Connect the product to a Samsung TV with the HDMI cable.
(See page 12)
2. Set the Anynet+ function on your TV to ON.
(See the TV instruction manual for more information.)



- Depending on your TV, certain HDMI output resolutions may not work.
- Please refer to the user's manual of your TV.
Please check the **Anynet+** logo (If your TV has an **Anynet+** logo, then it supports Anynet+ function.)

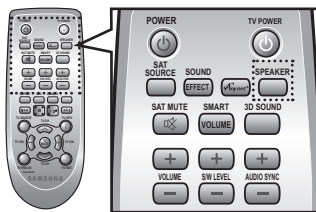

SPEAKER button

This button enables you to select between listening to audio from your TV or audio from the Air Track when connected via HDMI.

Press **SPEAKER** on the remote control of this unit.

AUDIO MODE	SPEAKER	Scroll Display	Display
HDMI IN	TV	TV SPEAKER	TV SPK
	Air Track	AVR SPEAKER	HDMI
ARC	TV	TV SPEAKER	S MUTE
	Air Track	AVR SPEAKER	TV ARC

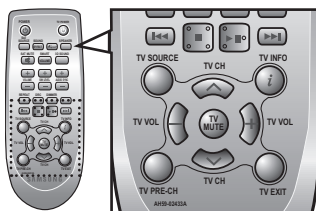

Using the TV functions

1. Press **TV SOURCE** on the remote control of this unit.
2. Press **TV INFO** on the remote control to display the TV channel information.
3. Press **TV CH** on the remote control to select the TV channel.
4. Press **TV VOL** on the remote control to increase or decrease the volume level.
5. Use **TV PRE-CH** button to move to the previous TV channel in TV mode.
6. To exit the TV menu, use the **TV EXIT** button. (Functions same as the EXIT button of the TV remote control)



- The remote control can operate TVs made by SAMSUNG only.

SOFTWARE UPGRADE

Samsung may offer upgrades for the Crystal Surround Air Track's system firmware in the future.

If an upgrade is offered, you can upgrade the firmware by connecting a USB drive with the firmware upgrade stored on it to the USB port on your Air Track.

Note that if there are multiple upgrade files, you must load them onto the USB drive singly and use them to upgrade the firmware one at a time.

Please visit Samsung.com or contact the Samsung call center to receive more information about downloading upgrades files.

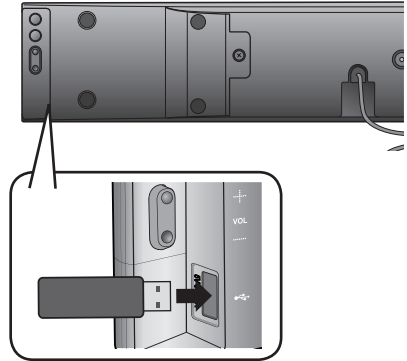

- Insert a USB drive containing the firmware upgrade into the USB port on the right corner of the front panel .
- Please be careful to not disconnect the power or remove the USB drive while upgrades are being applied. The main unit will turn off automatically after completing the firmware upgrade. When software is upgraded, settings you have made will return to their default (factory) settings. We recommend you write down your settings so that you can easily reset them after the upgrade.
- If the firmware fails to upgrade, we recommend formatting the USB data in FAT16 and trying again.
- For upgrading purposes, do not format the USB drive in NTFS format because it is not a supported file system.
- Depending on the manufacturer, the USB may not be supported.

troubleshooting

Before requesting service, please check the following.

Symptom	Check	Remedy
The unit will not turn on.	<ul style="list-style-type: none">• Is the power cord plugged into the outlet?	<ul style="list-style-type: none">• Connect the power plug to the outlet.
A function does not work when the button is pressed.	<ul style="list-style-type: none">• Is there static electricity in the air?	<ul style="list-style-type: none">• Disconnect the power plug and connect it again.
Sound is not produced.	<ul style="list-style-type: none">• Is the unit properly connected to your TV?• Is the Mute function on?• Is the volume set to minimum?	<ul style="list-style-type: none">• Connect it correctly.• Press the Mute button to cancel the function.• Adjust the volume.
The Picture does not appear on a TV when the function is selected.	<ul style="list-style-type: none">• Is the TV connected properly?	<ul style="list-style-type: none">• Connect it correctly.
The Remote control does not work.	<ul style="list-style-type: none">• Are the batteries drained?• Is the distance between remote control and main unit too far?	<ul style="list-style-type: none">• Replace with new batteries.• Operate at a close distance.
The sound from the left/right channels are reversed.	<ul style="list-style-type: none">• Are the left/right audio output cables from the TV connected properly?	<ul style="list-style-type: none">• Check the left/right channel and connect it/them correctly.

SPECIFICATIONS

Model name	HW-E350		
GENERAL	Weight	Main unit	2.2 kg
	Dimensions (W x H x D)	Main unit	734 x 85.1 x 80 mm
		Operating temperature range	+5 °C to +35 °C
	Operating humidity range	10 % to 75 %	
AMPLIFIER	Rated output power	Front	30W/CH, 8OHM, THD = 10%, 1KHz
		Subwoofer	60W/CH, 4OHM, THD = 10%, 100Hz
	Input sensitivity/Impedance	570mV/20Kohm	
	S/N ratio (analog input)	75dB	
	Separation(1kHz)	65dB	
FREQUENCY RESPONSE	Analog input	20Hz~20kHz(±3dB)	
	Digital input/48kHz PCM	20Hz~20kHz(±3dB)	

* S/N ratio, distortion, separation and usable sensitivity are based on measurement using AES (Audio Engineering Society) guidelines.

*: Nominal specification

- Samsung Electronics Co., Ltd reserves the right to change the specifications without notice.
- Weight and dimensions are approximate.
- For the power supply , refer to the label attached to the product.



Contact SAMSUNG WORLD WIDE

If you have any questions or comments relating to Samsung products, please contact the SAMSUNG customer care center.

Area	Contact Centre ☎	Web Site
▪ Asia Pacific		
AUSTRALIA	1300 362 603	www.samsung.com
NEW ZEALAND	0800 SAMSUNG (0800 726 786)	www.samsung.com
CHINA	400-810-5858	www.samsung.com
HONG KONG	(852) 3698 4698	www.samsung.com/hk www.samsung.com/hk_en/
INDIA	1800 1100 11 3030 8282 1800 3000 8282 1800 266 8282	www.samsung.com
INDONESIA	0800-112-8888 021-5699-7777	www.samsung.com
MALAYSIA	1800-88-9999	www.samsung.com
PHILIPPINES	1-800-10-SAMSUNG(726-7864) for PLDT 1-800-3-SAMSUNG(726-7864) for Digitel 1-800-8-SAMSUNG(726-7864) for Globe 02-5805777	www.samsung.com
SINGAPORE	1800-SAMSUNG(726-7864)	www.samsung.com
THAILAND	1800-29-3232 02-689-3232	www.samsung.com
TAIWAN	0800-329-999 0266-026-066	www.samsung.com
VIETNAM	1 800 588 889	www.samsung.com
▪ Middle East		
U.A.E	800-SAMSUNG (726-7864)	www.samsung.com
OMAN	800-SAMSUNG(726-7864)	www.samsung.com
KUWAIT	183-2255	www.samsung.com
BAHRAIN	8000-4726	www.samsung.com
Egypt	08000-726786	www.samsung.com
JORDAN	800-22273	www.samsung.com
IRAN	021-8255	www.samsung.com
Saudi Arabia	9200-21230	www.samsung.com
▪ Africa		
NIGERIA	0800-726-7864	www.samsung.com
Ghana	0800-10077 0302-200077	www.samsung.com
Cote D' Ivoire	8000 0077	www.samsung.com
Senegal	800-00-0077	www.samsung.com
Cameroon	7095- 0077	www.samsung.com
KENYA	0800 724 000	www.samsung.com
UGANDA	0800 300 300	www.samsung.com
TANZANIA	0685 88 99 00	www.samsung.com
SOUTH AFRICA	0860-SAMSUNG(726-7864)	www.samsung.com